



EUROPEAN CENTRAL BANK

**WORKING PAPER SERIES**

**NO 622 / MAY 2006**

BCE ECB EZB EKT EKP

**SHORT-TERM FORECASTS  
OF EURO AREA REAL  
GDP GROWTH**

**AN ASSESSMENT OF  
REAL-TIME PERFORMANCE  
BASED ON VINTAGE DATA**

by Marie Diron



EUROPEAN CENTRAL BANK



In 2006 all ECB publications will feature a motif taken from the €5 banknote.



## WORKING PAPER SERIES

NO 622 / MAY 2006

# SHORT-TERM FORECASTS OF EURO AREA REAL GDP GROWTH AN ASSESSMENT OF REAL-TIME PERFORMANCE BASED ON VINTAGE DATA<sup>1</sup>

by Marie Diron<sup>2</sup>

This paper can be downloaded without charge from <http://www.ecb.int> or from the Social Science Research Network electronic library at [http://ssrn.com/abstract\\_id=899266](http://ssrn.com/abstract_id=899266)

<sup>1</sup> This work was carried out when I was working at the European Central Bank. I am extremely grateful to Linda Kezberg from the Statistics department of the ECB, who provided me with the vintage data set and to Patrick Coe, Gerard Korteweg, Fabrice Orlandi, Frauke Skudelny, participants to the Euro Area Business Cycle Network workshop on real-time data, participants to the 2005 Canadian Economic Association meeting and an anonymous referee for useful comments and suggestions. All remaining errors are mine.

<sup>2</sup> Brevan Howard Asset Management LLP, London, SW1Y 6XA, United Kingdom; e-mail: [marie.diron@gmx.de](mailto:marie.diron@gmx.de).

© European Central Bank, 2006

**Address**

Kaiserstrasse 29  
60311 Frankfurt am Main, Germany

**Postal address**

Postfach 16 03 19  
60066 Frankfurt am Main, Germany

**Telephone**

+49 69 1344 0

**Internet**

<http://www.ecb.int>

**Fax**

+49 69 1344 6000

**Telex**

411 144 ecb d

*All rights reserved.*

*Any reproduction, publication and reprint in the form of a different publication, whether printed or produced electronically, in whole or in part, is permitted only with the explicit written authorisation of the ECB or the author(s).*

*The views expressed in this paper do not necessarily reflect those of the European Central Bank.*

*The statement of purpose for the ECB Working Paper Series is available from the ECB website, <http://www.ecb.int>.*

ISSN 1561-0810 (print)  
ISSN 1725-2806 (online)

## CONTENTS

Abstract	4
Non-technical summary	5
1 Introduction	6
2 Bridge equations for early estimates of euro area real GDP growth	7
3 Revisions in indicators of activity in the euro area	12
4 Impact of revisions on short-term forecasts of real GDP growth	14
4.1 Impact on assessment of reliability of the short-term forecasts	14
4.2 Impact on forecasts for individual quarters	15
5 Decomposition of sources of forecast errors	17
6 Conclusion	20
References	22
Tables and figures	23
Appendix: data sources and descriptions	35
European Central Bank Working Paper Series	36

## **Abstract**

Economic policy makers, international organisations and private-sector forecasters commonly use short-term forecasts of real GDP growth based on monthly indicators, such as industrial production, retail sales and confidence surveys. An assessment of the reliability of such tools and of the source of potential forecast errors is essential. While many studies have evaluated the size of forecast errors related to model specifications and unavailability of data in real time, few have provided a complete assessment of forecast errors, which should notably take into account the impact of data revision. This paper proposes to bridge this gap. Using four years of data vintages for euro area conjunctural indicators, the paper decomposes forecast errors into four elements (model specification, erroneous extrapolations of the monthly indicators, revisions to the monthly indicators and revisions to the GDP data series) and assesses their relative sizes.

The results show that gains in accuracy of forecasts achieved by using monthly data on actual activity rather than surveys or financial indicators are offset by the fact that the former set of monthly data is harder to forecast and less timely than the latter set. While the results presented in the paper remain tentative due to limited data availability, they provide a benchmark which future research may build on.

JEL classification: C22, C53, E17, E37, E66

Keywords: Forecasting, conjunctural analysis, bridge equations, real-time forecasting, vintage data.

## Non technical summary

Economic policy makers, international organisations and private-sector forecasters commonly use short-term forecasts of real GDP growth based on monthly indicators, such as industrial production, retail sales and confidence surveys. An assessment of the reliability of such tools and of the source of potential forecast errors is essential. Various studies for the euro area have provided a partial assessment of the reliability of short-term forecasts, based on so-called “pseudo real-time” exercises. These exercises are “real-time” in the sense that they mimic the actual real-time situation in terms of schedule of releases and thereby availability of monthly indicators. However, they are not genuine real-time assessments to the extent that they use current estimates of GDP and the monthly indicators, i.e. post revisions to the series. Evaluating the impact of data revisions is necessary to assess the genuine reliability of short-term forecasts since policy makers and businesses need to interpret them and use them in their decision making before data revisions become available.

Indeed, various studies have shown that revisions to economic series can be substantial, so much that monetary policy rules – which have been the focus of most studies on the impact of data revisions so far –, derived from revised data give significantly different indications from rules based on data and estimates available at the time they are calculated. These findings suggest that data revisions, which as shown in this paper are significant for euro area conjunctural indicators, could significantly affect short-term forecasts of GDP as well as the assessment of their reliability.

Using four years of data vintages, the paper provides estimates of forecast errors for euro area real GDP growth in genuine real-time conditions. The results presented in this paper provide support to previous pseudo real-time analyses in the sense that the overall assessment of reliability stemming from the pseudo real-time exercises does not seem to be biased by the use of revised rather than real-time data. In addition, the paper documents the relative roles of four sources of errors in short-term forecasts of real GDP growth: (a) errors due to differences between real GDP growth and the estimated relationship(s) with monthly variables; (b) errors due to erroneous assumptions on the monthly indicators for the missing months over the forecast period; (c) errors due to revisions in monthly indicators; and (d) “errors” due to revisions in GDP. The distinction between these sources of error provides guidance to practitioners about where further effort to improve the overall reliability of short-term forecasts should be concentrated. Illustrative examples show that gains in accuracy of forecasts achieved by using monthly data on actual activity rather than surveys or financial indicators are offset by the fact that the former set of monthly data is harder to forecast and less timely than the latter set. To our knowledge, this paper is the first one to check the validity of reliability assessments based on pseudo real-time experiments and to present quantitative estimates of the relative importance of the various sources of forecast errors. While the results presented in the paper remain tentative due to limited data availability, they provide a benchmark which future research may build on.

## 1. Introduction

Economic policy makers, international organisations and private-sector forecasters commonly use short-term forecasts of real GDP growth based on monthly indicators, such as industrial production, retail sales and confidence surveys. For users, an assessment of the reliability of these tools and of the source of potential forecast errors is essential. Traditionally, the economic literature on short-term forecasting has provided such an evaluation on the basis of so-called “pseudo real-time” experiments.<sup>1</sup> These exercises are “real-time” in the sense that they mimic the actual real-time situation faced by forecasters in terms of schedule of data releases and thereby availability of monthly indicators. Thus, the assessment of forecast uncertainty provided by these experiments takes into account forecast errors on the regressors. However, pseudo real-time experiments do not reflect the genuine real-time situation to the extent that they use current estimates of GDP and the monthly indicators, i.e. post revisions to the series.

Meanwhile, various studies have shown that revisions to economic series can be substantial, so much that monetary policy rules – which have been the focus of most studies on the impact of data revisions so far –, derived from revised data give significantly different indications from rules based on data and estimates available at the time they are calculated. Orphanides and van Norden (2002, amongst several papers by these authors on the topic), and Kozicki (2004) are examples of such studies.

These findings suggest that data revisions could significantly affect short-term forecasts of GDP as well as the assessment of their reliability. This paper is the first one to our knowledge to check whether this is the case or not for forecasts of euro area real GDP growth. Using vintages of data collected at the ECB since mid-2001, we replicate real-time forecasts of euro area GDP growth based on linear regressions on monthly variables – sometimes called “bridge equations”, a terminology which we use in this paper - which are widely used in central banks, private and international organisations. Similar to the study carried out in this paper, Robertson and Tallman (1998) assess real-time forecasts of US real GDP growth and industrial production based on the Composite index of economic Leading Indicators (CLI).

Besides, the use of real-time data enables to estimate the relative roles of the four possible sources of errors in short-term forecasts of real GDP growth: (a) errors due to differences between real GDP growth and the estimated relationship(s) with monthly variables; (b) errors due to erroneous assumptions on the monthly indicators for the missing months over the forecast period; (c) errors due to revisions in monthly indicators; and (d) “errors” due to revisions in GDP. The distinction between these sources of error which is provided in the paper provides guidance to practitioners about where further effort to improve the overall reliability of short-term forecasts should be concentrated.

---

<sup>1</sup> Examples of pseudo real-time forecasts of euro area real GDP include Sédillot and Rünstler (2003) and Baffigi et al. (2004)

One caveat to the results presented in this paper is that they are based on a dataset covering four years of statistic releases.<sup>2</sup> Our database is the most extensive real-time dataset currently available for the euro area to our knowledge but it is still relatively short to draw general conclusions. This paper should therefore be interpreted as a progress report on the analysis of data revisions on short-term forecasts of euro area real GDP, which could be usefully updated when more comprehensive data are available.

The paper is organised as follows. Section 2 briefly outlines the methodology of bridge equations used to obtain short-term estimates of real GDP growth based on monthly indicators. Several bridge equations are considered, which are meant to illustrate the trade-offs between timeliness, tightness of the relationship of the variables with GDP and sizes of revisions. Thus, some equations use data on actual activity, such as industrial production and retail sales, which are subject to significant revisions and are published with significant delays, while some use more indirect indicators of activity, such as confidence surveys and financial variables data, which are typically not revised and available on a timely basis. As a motivation for the exercise carried out in the paper, section 3 shows the average and maximum sizes of revisions to monthly indicators and to real GDP growth for the euro obtained from our real-time dataset. Section 4 calculates short-term forecasts of euro area real GDP growth with real-time and revised data. The former reflect actual forecasting conditions while the latter replicates the pseudo real-time exercises usually found in the literature. Comparing average forecast errors obtained from these two exercises therefore shows whether the assessment of reliability based on pseudo real-time exercises corresponds to actual conditions or not. Finally, Section 5 analyses the contributions of the four sources of forecast errors identified above.

## **2. Bridge equations for early estimates of euro area real GDP growth**

Bridge equations are commonly used to estimate short-term developments in real GDP growth. These linear regressions “bridge” monthly variables, such as industrial production and retail sales, and quarterly real GDP growth. The interest of these tools is twofold. First, they allow to combine into a synthetic indicator monthly information on various aspects of the economy, which at times may give conflicting signals. Second, and particularly relevant for the euro area given the publication delays of GDP data, bridge equations provide some estimates of current and short-term developments in advance of the release.

As an illustration, Figure 1 shows the timing of data releases on activity in the euro area during and for the second quarter of 2005. A flash GDP estimates – i.e. a release of GDP as a whole with no further information on the composition of growth – was released by Eurostat on 9 August 2005. The delay of 40-45 days (and around 70 days for the full release of national accounts) is a hindrance for economic analysis and monetary policy assessment. Before the flash GDP release however, information on activity in the second quarter had

---

<sup>2</sup> For the US, a widely used real-time dataset is maintained by the Federal Reserve Bank of Philadelphia, covering a wide range of series on activity and inflation and starting in the late 1960s. See Croushore and Stark (2001) for a description of this dataset.



become available. Thus, retail sales, which account for around 40% of euro area consumption, were known at the beginning of August. The results of the European Commission's (EC) surveys of business and consumer confidence were published at the beginning of July. In addition, even before the full second quarter of data for these indicators were available, partial information on developments in the first and second months released as of mid-May could be used to form an assessment of overall real GDP growth in advance of the data release.

In this paper, we use various types of monthly indicators, with different combinations of them.<sup>3</sup> The aim of the paper is not to select the 'best' combination of monthly indicators. Which combination is 'best' depends on one's purpose and different selection criteria (in-sample or out-of-sample tests to name two broad categories) provide different answers. Rather, our selection is guided by our aim to (a) test the validity of pseudo real-time tests as opposed to genuine real-time experiments and (b) quantify the relative importance of the four sources of forecast errors identified in introduction. In this view, three characteristics of the explanatory variables are key: size of revisions if any, timeliness and degree of tightness of the link between the variable and GDP growth. We test various combinations of monthly indicators which cover a broad range of possibilities along these three features. Most indicators used are contemporaneous indicators of growth: these include "hard" data, i.e. variables on actual production and demand, such as industrial production and retail sales and business and consumer confidence surveys. Within survey data, even the questions which may be thought a priori to be leading indicators of growth, such as businesses' production expectations appear to be coincident. Therefore, there is no issue about the appropriate lags to be included in the equations. For all these variables, contemporaneous values are used to explain GDP. Additional significance of lagged values was checked and rejected in all cases. The issue of the lag structure of the equations is limited to a third kind of indicators, financial variables. The strategy followed in this respect is explained further below.

First, we consider combinations of hard data. One bridge equation focuses on indicators of production in the main sectors of activity. Monthly series on industrial and construction production are available (noted IP and CTRP respectively). Since no monthly variables on value-added in services is available for the euro area, we use the quarterly series from the national accounts (VA\_SER), which, to obtain forecasts of GDP, we forecast with services confidence from the EC survey (SER\_CONF). Although the retail trade sector is included in VA\_SER and not in SER\_CONF, retail trade confidence was not significant when added in the regression of VA\_SER.

---

<sup>3</sup> Appendix 1 describes the data used.

$$d \log(GDP) = \alpha_0^1 + \alpha_1^1 * d \log(IP) + \alpha_2^1 * d \log(CTRP) + \alpha_3^1 * d \log(SER\_VA) \quad (1)^4$$

$$d \log(SER\_VA) = \gamma_0 + \sum_{i=0}^2 \beta_i SER\_CONF(-i)$$

The second equation uses monthly information on private consumption. Since this component accounts for around 55% of euro area GDP, capturing its developments should be key to being able to forecast GDP as a whole. Monthly series on euro area private consumption expenditure include retail sales (RS) and new passenger registrations (CARS). No monthly data are available on consumption of services. As regards the other expenditure components of GDP, apart from monthly data on trade of goods, no monthly series is available. Moreover, we found that when including industrial production in the regression, exports and imports of goods are no longer significant. Therefore, we combine retail sales and new car registrations with industrial production and construction production. Viewed from the expenditure approach of GDP, these two variables may be seen as proxies for investment and exports, although our approach is more pragmatic and does not necessarily follow from this interpretation.

$$d \log(GDP) = \alpha_0^2 + \alpha_1^2 * d \log(IP) + \alpha_2^2 * d \log(CTRP) + \alpha_3^2 * d \log(RS) + \alpha_4^2 * d \log(CARS) \quad (2)$$

These two bridge equations are close to simple accounting, since the monthly variables used are components of GDP and are based on data sets used by National Statistical Institutes to estimate GDP data. The other bridge equations used in this paper rely on more indirect indicators, such as survey data and financial variables. While the relationship between GDP and these indirect indicators should be looser than with the component indicators, the advantages in using such indicators are their timeliness, the fact that they cover some areas of activity on which no hard data are available and, as we will see in the decomposition of forecast errors of section 5, the fact that they are not revised.

Thus, the third equation relates real GDP growth to the European Commission's Economic Sentiment Indicator (ESI), which combines confidence in the manufacturing, construction, retail and non-retail services sector, with consumer confidence.

$$d \log(GDP) = \alpha_0^5 + \alpha_1^5 * ESI + \alpha_2^5 * d \log(GDP(-1)) \quad (3)$$

One main advantage of this equation is parsimony. One drawback however is that the weights attributed to the various confidence indicators in the ESI are somewhat ad-hoc. The fourth and fifth equations therefore use the different confidence surveys separately.

The fourth equation is similar to equation (1) in that it relates on business confidence surveys for various sectors of activity. Confidence surveys are available for four main sectors of activity: manufacturing,

---

<sup>4</sup> In all equations, we allowed for inclusion of lagged GDP growth. The variable was not significant, except for the regression on the Economic Sentiment Indicator and, the one on the OECD leading indicator shown below.

construction, retail trade and other market services. Construction and retail trade confidence were found to be insignificant, reflecting very high volatility of these series. Therefore, our fourth equation is written as:

$$d \log(GDP) = \alpha_0^3 + \alpha_1^3 * d(MAN\_CONF) + \alpha_2^3 * SER\_CONF \quad (4)^5$$

The fifth equation is similar to the second one, but using survey data. Thus, we include consumer confidence, (CONS\_CONF), which aims at capturing developments in consumption. Business confidence variables are used to proxy for non-consumption demand variables. Amongst all possible combinations of the various business confidence indicators with consumer confidence, one retaining manufacturing and retail trade confidence gives the most accurate forecasts.<sup>6</sup>

$$d \log(GDP) = \alpha_0^4 + \alpha_1^4 * d(MAN\_CONF) + \alpha_2^4 * RET\_CONF + \alpha_3^4 * CONS\_CONF \quad (5)$$

The sixth equation uses financial variables, which are sometimes included in bridge equations.<sup>7</sup> While the indicators used in equations (1) to (5) are coincident indicators of GDP, financial variables tend to be leading. However, in this case, economic theory and experience provide no clear guidance as regards the structure of the equation. Our approach therefore aimed to be agnostic. All possible combinations of the euro effective exchange rate (EER), the yield spread between 10-year government bond rates and 3-month interest rates (SPREAD) and a stock market price index deflated by the HICP inflation (SPI). For each variable, lags of up to two quarters were tested. The following specification was retained<sup>8</sup>:

$$d \log(GDP) = \alpha_0^5 + \alpha_1^5 * SPREAD + \alpha_2^5 * d \log(EER(-2)) + \alpha_3^5 * d \log(PIR(-1)) \quad (6)$$

Finally, equations 7 and 8 make use of two composite indicators for growth in the euro area, the OECD leading indicator (OECD\_LI) and the EuroCOIN respectively.<sup>9</sup> These indicators are often used as summary indicators of activity developments in the euro area. Other lag structures, notably using lagged values of the indicators, were tested, again with the algorithm referred to in footnote 5, but gave either identical or worse results in terms of forecasting accuracy.

<sup>5</sup> The questions of the EC's business confidence survey are asked in terms of changes in activity compared with the previous months. The levels of the surveys should therefore be related to GDP growth. However, for manufacturing, the levels appear to be lagging, while quarter-on-quarter differences give better forecasting results.

<sup>6</sup> I am grateful to Fabrice Orlandi of the ECB who provided me with an algorithm which estimates all possible combinations of a set of candidate indicators and ranks them according to either in-sample information criteria or out-of-sample Root Mean Square Error. I chose RMSEs as a selection criterion.

<sup>7</sup> For instance, the European Commission's indicator on euro area real GDP growth published by DG-ECFIN until October 2005 uses the euro effective exchange rate and the difference in interest rate spreads between Germany and the US. The indicator published by Euroframe, a network of private sector forecasting institutes also uses the euro/dollar exchange rate and euro area 3-month interest rates.

<sup>8</sup> Using the algorithm mentioned in footnote 5.

<sup>9</sup> The OECD leading indicator is an aggregation of composite indicators for the euro area countries. At the country level, component series are combined with equal weights. See <http://www.oecd.org/dataoecd/4/33/15994428.pdf>. As regards the EuroCOIN see Altissimo et al. (2001). The EuroCOIN is an indicator based on a factor model published by the CEPR. It is based on a very large data set of euro area and national series. See <http://www.cepr.org/data/eurocoin/>

$$d \log(GDP) = \alpha_0^6 + \alpha_1^6 * d \log(OECD\_LI) + \alpha_2^6 * d \log(GDP(-1)) \quad (7)$$

$$d \log(GDP) = \alpha_0^7 + \alpha_1^7 * EUROCOIN \quad (8)$$

All the equations are estimated as of the first quarter of 1990. We use the bridge equations (1) to (8) to calculate short-term forecasts of euro area real GDP growth from the second quarter of 2001 to the fourth quarter of 2004, which is the period covered by the real-time data set. We replicate a real-time situation so that:

- (a) Only the information available in real time is used. Thus, when replicating the forecasts which would have been produced in July 2001, the July 2001 vintages are used which include for instance, data on real GDP growth up to the first quarter of 2001 and industrial production and retail sales up to May 2001. Contrary to pseudo real-time exercises carried out in other research, our experiment thus mimics the real-time situation not only in terms of amount of data available (i.e. the fact for instance that in July 2001, industrial production in the last month of the second quarter of 2001 is not known yet), but also in terms of relying on statistics which will be revised after the forecast is made.
- (b) Taking the above example of the July 2001 forecasts, monthly variables are only partially known for the quarter after the last GDP data, the second quarter of 2001. Therefore, they need to be extrapolated for the remainder of the second quarter of 2001 and for the rest of the forecast horizon. In the results shown below, extrapolation is made with univariate AR equations of the monthly data, using 6 lags. More elaborated schemes such as small VARs were also considered but failed to improve the forecasting results.<sup>10</sup> We extrapolate the monthly variables (and value-added services using data and extrapolations of services confidence) six months ahead. Thus, six different forecasts of real GDP growth in a given quarter are produced, with increasing amount of information on the indicators being used in place of extrapolations. We denote these various forecasts as follows. Since the release of flash GDP estimates for the euro area, the first data on real GDP growth in given quarter Q are known in the second month of the following quarter, which we note “Q+1,M2”. Forecasts made in the previous month, “Q+1,M1”, include a full set of data for new passenger car registrations, surveys and financial variables and two months of data for industrial and construction production, retail sales, the OECD leading indicator and the EuroCOIN. Previous forecasts rely on less information, up to the first forecast of growth in Q, made in the second month of the previous quarter “Q-1, M2” which is based on data for new passenger car registrations, surveys and financial variables up to Q-1, M1 and on data up to Q-2, M3 for industrial and construction production, retail sales, the OECD leading indicator and the EuroCOIN, which are completed with 6 months of extrapolations. Figure 2 shows the timing of these forecasts for the second quarter of 2005.

<sup>10</sup> Sédillot and Rünstler (2003) had found that using extrapolations based on VARs and Bayesian VARs improved the accuracy of GDP forecasts for the quarter ahead.



- (c) The bridge equations and the extrapolating ARs are re-estimated on a rolling basis. More precisely, the structure of the equations is kept constant and the coefficients are re-estimated.<sup>11</sup> Thus, the July 2001 forecasts for real GDP growth in the second and third quarters of 2001 rely on estimations of the bridge equations with the July 2001 vintages up to the first quarter of 2001. In order to obtain forecasts for the next two quarters, the indicators are extrapolated six months ahead of the last data point (June 2001 for surveys, May 2001 for industrial production etc.). Then the process is moved forward by one month. The bridge equations are estimated with the August 2001 vintage, the indicators, as contained in this vintage, are extrapolated six months ahead and forecasts for the second and third quarters of 2001 are calculated. In the following month, GDP data for the second quarter of 2001 are published. The forecasting process therefore shifts one quarter.
- (d) All the forecasts from the eight bridge equations are saved and the average of forecasts across the equations is calculated.

Forecast errors are calculated and Root Mean Square Errors (RMSEs) are used as a summary statistic for forecast evaluation. Other statistics such as the Mean Absolute Error give similar results to those presented in the paper. One important point is the choice of the GDP series against which forecasts are compared. Should we use current estimates of GDP or earlier vintages, for instance, first releases of GDP? There are pros and cons to both approaches. In forecast evaluation exercises, the latest estimates of GDP growth, i.e. including revisions to past data, are generally used. It is argued that these estimates are closer to “true” GDP growth than earlier vintages, which should indeed be the case to the extent that data revisions incorporate more information and changes in estimation techniques are aimed at capturing activity developments better. However, users of real GDP data, such as policy makers, need to make decisions on the basis of preliminary estimates. Being able to forecast these preliminary estimates, notwithstanding future revisions to them, is therefore also relevant. In this paper, we calculate forecast errors both against first GDP releases<sup>12</sup> and against final estimates.

### 3. Revisions in indicators of activity in the euro area

This section reports evidence on revisions to data on activity in the euro area. This preliminary step provides a justification to the subsequent analysis since it is only justified to the extent that revisions are significant. If not, previous research based on revised series suffices to provide an accurate assessment of reliability of the short-term forecasts of GDP growth.

---

<sup>11</sup> In our set-up whether the structure of the equations should be allowed to vary over time or not is a minor issue since, apart from equations (6) to (8) for which the lag structure is not obvious, the structure of the other equations is unambiguous.

<sup>12</sup> i.e. GDP flash estimates since their first release in May 2003 and the first release of national accounts before that date.

Real-time data have been collected at the European Central Bank since July 2001, thereby providing nearly four years of history of revisions. Up to March 2005, this data set contains 45 monthly vintages.<sup>13</sup> Obviously, further revisions will be shown in forthcoming data releases, especially for activity developments in the more recent period. In this view, the results presented below provide some lower bounds of typical revisions to euro area data.

Table 1 shows standard statistics on revisions between the first estimates and the March 2005 vintages for the indicators used in this paper. It should be noted that the CEPR only publishes the values of the EuroCOIN for the last six months. The size of revisions shown in Table 1 therefore underestimates the actual revisions to the EuroCOIN related to revisions in its component series. Revisions to survey data which are seldom and marginal are not shown in the Table. Finally, financial variables are not revised. The table also shows the average and maximum difference between the highest and smallest estimates of a series in a given quarter across the 45 vintages. In order to better evaluate the size of revisions and of the gap between the largest and lowest estimates, the average and standard deviations of the series are shown. Figure 3 provides more detail on the revisions by plotting the current (i.e. March 2005) estimates of the series against the first estimates for the 15 quarters of the sample (second quarter of 2001 to fourth quarter of 2004). In the absence of revision, the points would all be on the diagonal.

The main features of revisions are the following.

- First, there is no evidence of bias in the first estimates of the series, except for growth in construction production which has been underestimated in the first releases by around 0.6 percentage point on average in the period since mid-2001. This is visible on the middle right panel of Figure 3, where a larger part of the weight of the cluster of dots is below the diagonal.
- Second, in absolute terms, revisions to the monthly indicators are relatively large. For instance, the root mean square revisions of growth in industrial production and retail sales, two key indicators of activity, are 0.4 and 0.3 percentage point respectively, nearly as large, or for retail sales, larger than the average absolute growth rate of the series. Revisions to construction production are particularly large: at 2.5 percentage points on average, they are larger than the growth rate of the series and even larger than its standard deviation. Revisions to GDP growth are relatively smaller, probably on account of the fact that revisions to the indicators entering its calculation tend to offset each other. To some extent, such an offsetting process may be at play for value-added in services as well.
- Third, revisions to estimates in specific quarters can be very large as shown in the sixth column of Table 1. Typically, the largest revision in the sample is of the order of magnitude of one standard deviation of the series. Construction production is an exception since the largest revision is nearly 5 times

---

<sup>13</sup> Since industrial production is a key variable in driving short-term forecasts of GDP, we retain vintages available at the time of the publication of euro area industrial production data, which occurs towards the middle of the month.

as large as the standard deviation of the series. In August 2004, with the release of data for June 2004, construction production was estimated to have fallen by 5.7% quarter-on-quarter in the second quarter of 2004. Nine months later, in March 2005, this has been revised to a much more moderate fall, by 0.8% only. For GDP growth, the largest revision in the sample considered is 0.2 percentage point, with several instances of revisions of this order of magnitude.

- Finally, revisions in a given month are sometimes reversed subsequently. Thus, the gaps between the largest and smallest estimates of growth in a given quarter across the different vintages are wider than the revision between the first and current estimates. These gaps are typically as large as the standard deviation of the series on average and, at times, much larger.

Overall therefore, revisions to monthly indicators appear significant, potentially large enough to imply that the assessment of real GDP growth in real time could differ from an assessment made on the basis of revised data.

#### **4. Impact of revisions on short-term forecasts of real GDP growth**

We evaluate the impact of data revisions on short-term forecasts of GDP growth in two respects. First, we check whether the assessment of reliability of short-term forecasts of real GDP growth differs when using real-time data from the assessment based on pseudo real-time exercises. This analysis is relevant to users of such short-term forecasts. Indeed, users typically put more or less confidence in the latest results produced by these tools depending on some assessment of their average reliability. Since the reliability gauge is most commonly based on pseudo real-time exercises, it is important to check whether these metrics reflect genuine reliability in real-time or not.

Second, we look at whether forecasts of real GDP growth in individual quarters differ depending on whether they are based on real-time or revised data. This analysis is a more detailed assessment than the comparison of average reliability measures. It is in the same spirit as research on the impact of data revisions on monetary policy rules mentioned in introduction. The question addressed is thus whether the assessment of the short-term outlook, which in genuine forecasting conditions is based on preliminary data, would have differed significantly if analysts had known forthcoming data revisions.

##### *4.1. Impact on assessment of reliability of the short-term forecasts*

Tables 2a and 2b show the RMSEs obtained with real-time data, where forecast errors are calculated against current estimates and first estimates of GDP growth respectively. Tables 3a and 3b report the differences between these RMSEs and the RMSEs of a pseudo real-time exercise (i.e. using current estimates of the indicators and of GDP). As a benchmark, results for AR forecasts of GDP, i.e. forecasts based on no other information than lagged GDP growth, are reported along with the results of the 8 bridge equations and of the average forecast.

To start with, this exercise confirms two findings of previous studies on forecasting. First, it shows that short-term forecasts of euro real GDP growth based on bridge equations are informative: using monthly indicators generally reduces forecast errors compared with AR forecasts of GDP. The difference in forecast accuracy is significant according to Diebold Mariano tests.<sup>14</sup> The information content of bridge equations is more clearly visible when errors are calculated against current estimates of real GDP growth (Table 2a) than when they are calculated against first estimates of GDP growth (Table 2b). Such differences may not be robust to larger test samples however. Second, in line with the findings of the literature on forecast pooling, errors on the average forecast tend to be as small as or smaller than errors on individual forecasts.

Turning to the specific issues addressed in this paper, the RMSEs based on pseudo real-time exercises are very similar to those calculated with the vintage data set (Tables 3a and 3b). This gives support to previous pseudo real-time exercises in the sense that our experiment suggests that the degree of reliability indicated by this literature is valid. This is true both for the average forecast and for individual equations. In particular, despite the significant revisions to monthly “hard” data shown in section 3, there is no evidence that pseudo real-time exercises would give a more misleading view on the reliability of short-term forecasts using this type of monthly indicators (equations 1 and 2) than for bridge equations based on indicators not subject to revisions (equations 3 to 6). Differences in RMSEs between real-time and pseudo real-time exercises are somewhat larger when real-time forecasts are assessed against first estimates of GDP than when they are measured against current estimates (Table 3b vs. Table 3a). In fact, taking first estimates of GDP as a benchmark, the RMSEs of real-time exercises are typically smaller than the RMSEs of pseudo real-time experiments.<sup>15</sup> Thus, when current estimates of GDP are taken as a reference, pseudo real-time exercises and real-time exercises give nearly the same RMSEs. When first estimates of GDP are used instead, the RMSEs of pseudo real-time exercises are around 0.05 percentage point and up to 0.08 percentage point larger than the RMSEs of real-time exercises. This result, as before, may be related to the specific sample available for the current study. However, at least, there is no evidence that the assessment of forecast reliability of short-term forecasts of GDP based on pseudo real-time exercises is too optimistic.

#### *4.2. Impact on forecasts for individual quarters*

Beside the assessment of average reliability, we check whether forecasts for individual quarters would differ if based on revised data from those made on preliminary series. Summary statistics of the difference between

---

<sup>14</sup> In line with Harvey, Leybourne and Newbold (1997), we correct the Diebold Mariano (1995) statistics for short-sample bias. For the one quarter ahead forecasts, we also apply the Newey-West type of correction of variance estimates for heteroscedasticity.

<sup>15</sup> This is also what Robertson and Tallman (1998) found for forecasts of US real GDP growth based on the CLI based on a much larger real-time dataset.



forecasts obtained in the real-time and forecasts replicated in pseudo real-time exercises are reported in Table 4.

For the average forecast across equations, differences are small. They are close to zero on average (no more than 0.05 percentage point in absolute terms), whatever the amount of monthly data available and the largest difference in forecasts over the sample is smaller than 0.10 percentage point. Providing more detail, Figure 4 plots these forecasts, with the values of forecasts based on current estimates read on the horizontal axis against the values of forecasts obtained from real-time data on the vertical axis. Each panel corresponds to one of the six possible situations in terms of availability of information on the indicators. Differences between the two sets of forecasts are small (the dots are close to the diagonal on Figure 4). For instance, these differences are smaller than the RMSEs of the forecasts shown in Table 2. Uncertainty on the short-term forecasts due to possible data revisions seems therefore smaller than overall uncertainty attached to these forecasts.

For some equations and some quarters however, forecasts based on revised data differ from forecasts based on real-time data. As expected, forecasts based on the first two equations, which rely on hard data, are less robust to data revisions than forecasts based on surveys and financial variables. For these two equations, the two sets of forecasts can differ by up to 0.30 percentage point. In relation to the typical quarter-on-quarter growth rates of euro area real GDP, such a gap implies different signals given by the two sets of forecasts. Figure 5 shows scatter plots of forecasts for individual quarters based on real-time and current estimates for the first two equations. The furthest away the dots are from the diagonal, the largest the impact of data revisions on these forecasts. It may be noted that differences are larger for forecasts based on relatively comprehensive information on the indicators (made at “Q+1, M1” and “Q, M3” for instance). By comparison, the forecasts made earlier and based on less information on the indicators are more robust to data revisions. This is because the extrapolations used in these forecasts would typically set growth in the indicators close to their historical average, which is about the same in real-time data and revised data. By contrast for the “Q+1, M1” and “Q, M3” forecasts, the extrapolations only extend to one or two months and are therefore significantly influenced by the vintage of data used. Different extrapolations compound with different data for the first month(s) of the quarter to produce sometimes significantly different forecasts of GDP growth.

The results for GDP forecasts based on the OECD leading indicator are similar to those of the first two equations, which is not surprising since the leading indicator includes data subject to revisions such as industrial production.

The results of forecasts based on the EuroCOIN are affected by one outlier for the second quarter of 2002, for which forecasts based on revised data are 0.7 percentage point higher than forecasts based on real-time data. A combination of two factors generates this very large discrepancy. First, data for the EuroCOIN for the

fourth quarter of 2001 have been revised upwards since the first estimates. The AR extrapolations based on the real-time – lower - data, therefore produces weaker readings for first quarter of 2002 than extrapolations based on current estimates of the EuroCOIN. In addition, first quarter of 2002 marks a turning point in the EuroCOIN. Thus, while the extrapolations of late 2001 and early 2002 extend the then estimated low levels of the EuroCOIN onto second quarter of 2002, revised data, which are significantly higher for this period imply higher extrapolations. This example, while a clear outlier in the sample of forecasts available, points to the possible risks of significantly misleading assessment based on pseudo real-time experiments about the information content of short-term forecasts in real time.

## 5. Decomposition of sources of forecast errors

The use of real-time data allows to decompose errors in short-term forecasts into various sources. Being able to identify the main source of error should help focus work to help improve the reliability of these forecasts.

Let us write the overall forecast error (for a given equation, a given quarter, and a given time at which the forecast is made, which we do not indicate to simplify notations):

$e = d \log(GDP_{current}) - FCST_{GDP:RT}^{Ind:RT,extrap}$  where the subscript “GDP:RT” indicates that the forecast is calculated using real-time data of GDP and the superscript “Ind: RT, extrap” denotes that real-time series of the indicators, and extrapolations thereof are used. This error therefore corresponds to the difference between real GDP growth as currently known and reported forecasts made in genuine real-time settings.

We can decompose  $e$  into four components:

1) errors due to a mismatch between real GDP growth and the indicators, i.e. the equations’ residuals. We note this component  $e_{eq}$  and write it as:

$$e_{eq} = d \log(GDP_{current}) - FIT_{GDP:current}^{Ind:current,data} \text{ where:}$$

$FIT$  refers to fitted values of the equation, i.e. the GDP growth rates predicted by the equation when the right-hand side variables take their actual values;

the subscript “GDP: current” indicates that the forecast is calculated using current data of GDP

the superscript “Ind: current, data” denotes that the current series of the indicators, with no extrapolation (i.e. using actual data) are used to calculated fitted values of the equation.

This component is therefore calculated ex-post, once the indicators values are known and data have been revised.

2) errors due to erroneous extrapolations of the indicators over the forecast horizon:

$$e_{ext} = FIT_{GDP:RT}^{Ind:RT,data} - FCST_{GDP:RT}^{Ind:RT,extrap} \text{ where:}$$

the superscript “*Ind: RT, data*” denotes that the real-time data series of the indicators, with no extrapolation (i.e. using actual data) are used to calculate fitted values as opposed to the current data used in 1).

FCST refers to the equation’s forecast for GDP growth;

the superscript “*Ind: RT, extrap*” denotes that extrapolations of the right-hand side variables are used to obtain the GDP forecast. This is needed when, for instance, one wants to forecast GDP growth in a given quarter but that industrial production data are only known up to the first month of the quarter.

Thus, differences between  $FIT_{GDP:RT}^{Ind:RT,data}$  and  $FCST_{GDP:RT}^{Ind:RT,extrap}$  are accounted for by differences between the extrapolated values of the indicators and their first released estimates. They can be calculated as soon as the values of the indicators over the forecast horizon are published.

3) errors due to revisions in the indicators:

$$e_{rev\_ind} = FIT_{GDP:RT}^{Ind:current,data} - FIT_{GDP:RT}^{Ind:RT,data} \text{ with:}$$

“*Ind: current, data*” implying that the fitted values are calculated with the current estimates of the indicator.

By definition, this component is zero for forecasts based on survey data and financial variables which are not revised.

4) and errors due to revisions in GDP data:

$$e_{rev\_GDP} = FIT_{GDP:current}^{Ind:current,data} - FIT_{GDP:RT}^{Ind:current,data}$$

The difference between the two components of this defining identity is accounted for by differences between the first releases of GDP growth and the current estimates which affect the estimated coefficients in equations (1) to (8).

With these definitions, we can verify that  $e = e_{eq} + e_{ext} + e_{rev\_ind} + e_{rev\_GDP}$

While errors due to data revisions,  $e_{rev\_ind}$  and  $e_{rev\_GDP}$ , are beyond the control of forecasters, research can be focused on reducing errors related to the specification,  $e_{eq}$ , and to the extrapolation scheme,  $e_{ext}$ .

Figure 6 plots the average size of the four sources of errors for each of the eight bridge equations and for the average forecast. The horizontal axis shows how the contributions of the various sources change, as more information on the indicators becomes available. Note that the chart shows errors in Root Mean Square Error terms, so that the four sources do not add up to the overall RMSE. The covariances between errors of the different sources, which account for the difference between the overall RMSE and the sum of RMSEs of the

four sources, tend to be small and show no specific pattern. They are therefore abstracted from in the following discussion.

Focusing first on the average forecast, the largest part of forecast errors stems from the equations,  $e_{eq}$ . The root mean square equation error is around 0.2 percentage point, i.e. between 100% (when information on the indicators is nearly complete, i.e. at “Q0, M1”) and 60% of the overall RMSE (when the indicators are extrapolated five to six months ahead, i.e. at “Q2, M2”). Errors stemming from extrapolations of the indicators decrease as more data become available and replace the extrapolations. Thus, while this source of error accounts for around 0.15 percentage point when the indicators are extrapolated five to six months ahead, it contributes nearly nothing to the overall error for forecasts made shortly before the release of GDP data (i.e. at “Q0, M1”). Meanwhile, revisions to the monthly variables and to GDP growth account for only a small share of the overall forecast errors, with root mean square errors around 0.05 percentage point for each of these two sources.

Second, looking at the results across equations, the relative sizes of the various sources of errors vary between specifications. One common feature is that equations’ errors are significant in all cases: the root mean square equation errors range between 0.13 percentage point for equation 1, which uses industrial production, construction production and value-added of services, to 0.25 percentage point for the equations using the ESI, the EuroCOIN and the OECD leading indicator. Since Tables 2 showed that the overall RMSE was not systematically smaller for equation 1 than for the other equations it implies that a better specification is offset by effects from erroneous extrapolations and from data revisions.

One other feature generally true for all equations is that the root mean square errors related to revisions in GDP growth tend to be relatively small. The two exceptions to this result are the equations using the ESI and the OECD leading indicator. These equations happen to be the only ones which include lagged GDP growth. This lagged term implies that revisions to GDP growth not only affect the estimated elasticities of GDP to the indicators, as is the case for the other equations. Revisions to GDP growth also imply changes to the GDP forecast due to the lagged GDP growth rate on the right hand side of the equation.

As regards errors due to erroneous extrapolations of the indicators, although they always decrease as more data become available and therefore extrapolations are limited to fewer months for all the equations, the relative contributions of this source of error vary from less than 0.1 percentage point for the equations using the ESI and financial variables to significantly more for the other equations. For the ESI, the smoothness of the series implies that the AR extrapolations are generally relatively accurate. As regards financial variables, the exchange rate and share prices enter the equations with lags, by two and one quarters respectively. Therefore, the forecasts made at a given point in time, rely to a lesser extent on extrapolations of the indicators and to a greater on data for these indicators than for the other equations. It may seem surprising that errors in extrapolations of survey indicators can contribute so much to the overall error: for equations 4 and 5, the related RMSE increases up to 0.35 and 0.20 percentage point respectively. This is due to the fact

that, in these equations, manufacturing confidence is used in quarter-on-quarter changes, a measure which is more volatile and thereby less well captured by AR extrapolations, than levels.

Finally, errors due to revisions in the monthly variables are significant in the two cases where they were expected to be: equations 1 and 2 which use hard data. As mentioned above, these errors are strictly zero for the three survey-based equations and for the equation using financial variables. They are small for the two equations based on the leading indicators. In the case of the EuroCOIN, recall however that available data only convey a partial picture of revisions in this indicator.

## 6. Conclusion

Using vintages of data on activity in the euro area, this paper assesses the impact of data revisions on short-term forecasts of real GDP growth. The question is relevant to users of short-term forecasts, analysts and policy makers, which need to interpret them in real time. While selection of the short-term forecasting equations would ideally be based on real-time data, such calculations are computationally burdensome. Pseudo real-time exercises, which rely on revised series and are therefore easier to set up are often used instead.

Given the size of revisions to indicators of activity documented in the paper, the assessment of reliability of short-term forecasts based on revised series could potentially give a misleading picture. In fact, the paper shows that the average reliability measures of pseudo real-time exercises seem valid. In addition, averaging across several equations, forecasts for individual quarters tend to be similar whether they are based on preliminary or revised data. These results therefore provide legitimacy to pseudo real-time exercises. However, our results also call for some degree of caution when selecting short-term forecasting tools from pseudo real-time exercises and when interpreting their results. Indeed, looking at specific equations and specific quarters, significant differences occur between forecasts based on revised series and forecasts based on real time data. The differences are sometimes large enough to give a different picture of activity developments.

The second contribution of the paper is to analyse the contributions of the various sources to the overall forecasting errors. For average forecasts across several equations, the main source of error is a specification error, i.e. mismatch between real GDP growth and the indicators used. Errors stemming from extrapolations of the indicators are also significant when the indicators need to be extrapolated five or six months ahead but decrease rapidly as more data become available and replace the extrapolations. Meanwhile, revisions to the monthly variables and to GDP growth account for only a small share of the overall forecast errors. This average result varies somewhat when considering individual specifications. In general, the specification errors are found to be significant, although somewhat smaller for equations using “hard data” than for equations using surveys or financial variables. Conversely, errors related to revisions in GDP growth tend to be relatively small, except when lagged GDP growth enters the equation. The relative contributions of

erroneous extrapolations and of revisions to the monthly indicators vary depending on whether the equations include hard data, in which case both sources are significant, or survey or financial variables, in which case the contributions of these sources to the overall forecast errors tend to be smaller. Thus, there seems to be a trade-off between better specifications based on hard data and smaller errors due to revisions and extrapolations obtained when forecasts are derived from surveys and financial variables.

Although based on the largest real-time dataset for the euro area currently available to our knowledge, the results presented in this paper should still be seen as some interim report which may be updated once more comprehensive vintages become available.

## References

- Baffigi Alberto, R. Golinelli and G. Parigi, (2004), “Bridge models to forecast euro area GDP”, *International Journal of Forecasting*, vol 20 pp 447-460.
- Altissimo F. et al., (2001), “EuroCOIN: A Real Time Coincident Indicator of the Euro Area Business Cycle”, *CEPR working paper* #3108
- Croushore D. and T. Stark, (2001) “A real-time dataset for macroeconomists”, *Journal of Econometrics*, vol 105, pp 111-130.
- Diebold F.X. and R.S. Mariano, (1995) “Comparing predictive accuracy”, *Journal of Business and Economic Statistics* vol 13(3), pp 237-252.
- Gaghestani H., (2004), “Are preliminary data of output growth and inflation reliable predictors?”, *Journal of Applied Business Research*, Summer 2004, vol 20(3)
- Harvey D., S. Leybourne and P. Newbold, (1997), “Testing the equality of prediction mean squared errors”, *International Journal of Forecasting*, vol 13, pp 281-291
- Kozicki S., (2004), “How do data revisions affect the evaluation and conduct of monetary policy”, *Federal Reserve Bank of Kansas city, Economic Review*, First quarter 2004
- Orphanides A. and S. van Norden, (2002), “The reliability of output gap estimates in real time”, *Review of Economics and Statistics*, vol 84(4), pp 569-583.
- Robertson John C. and E. W. Tallman, (1998), “Data vintages and measuring forecast model performance”, *Federal Reserve Bank of Atlanta, Economic Review*, Fourth quarter 1998
- Sédillot Franck and Rünstler G., (2003), “Short-term estimates of euro area real GDP by means of monthly data”, *ECB Working paper* #276
- Tashman L.J., T. Bakken, J. Buzas, (2000), “Effect of regressor forecast error on the variance of regression forecasts”, *Journal of Forecasting* vol 19(7), pp 587-600

**Table 1: Revisions in euro area real GDP and indicators**  
*Measured on the quarter-on-quarter growth rates of the variables*  
*Revisions in data published since July 2001 - Sample: 2001Q2-2004Q4*

	<i>Memorandum items</i>			Revision			Gap between largest and smallest	
	<i>Average growth</i>	<i>Av absol growth</i>	<i>Standard deviation</i>	Mean	Root mean square	Maximum	Mean	Maximum
Real GDP	0.3	0.3	0.3	0.0	0.1	0.3	0.1	0.3
Industrial production	0.1	0.6	0.8	0.1	0.4	0.8	0.7	1.3
Retail sales	0.0	0.2	0.3	-0.1	0.3	0.3	0.9	2.0
New car registrations	-0.4	2.3	2.9	-0.2	1.6	2.6	2.5	4.2
Construction production	0.1	0.7	1.0	0.6	2.5	4.8	3.8	6.0
Value added in services	0.3	0.3	0.2	0.0	0.1	0.2	0.2	0.3
EuroCOIN (level)	0.4	0.4	0.2	0.0	0.1	0.1	0.2	0.8
OECD leading indicator	0.7	0.9	1.1	0.1	0.3	0.7	0.7	1.7

*Note: the CEPR only publishes the latest six months of data. Revisions to the EuroCOIN are therefore not comparable to revisions for the other series*



**Table 2a: Real-time exercise: RMSEs of forecasts of euro area real GDP growth***Percentage points - Sample: 2001Q2-2004Q4**Forecasts assessed against current estimates of GDP growth*

	Q+1, M1	Q,M3	Q,M2	Q,M1	Q-1,M3	Q-1,M2
Benchmark AR of GDP	0.31	0.28	0.30	0.32	0.32	0.35
Average forecast	0.20	0.20	0.21	0.26	0.27	0.29
Equation 1 IP, CTRP, SER_VA	0.20	0.23	0.25	0.30	0.29	0.29
Equation 2 IP, CTRP, RS, CARS	0.25	0.25	0.31	0.33	0.30	0.30
Equation 3 ESI	0.29	0.25	0.27	0.29	0.28	0.30
Equation 4 MAN_CONF, SER_CONF	0.19	0.21	0.25	0.23	0.27	0.33
Equation 5 MAN_CONF, RET_CONF, CONS_CONF	0.26	0.25	0.27	0.29	0.31	0.31
Equation 6 FINANCIAL	0.26	0.23	0.24	0.24	0.26	0.29
Equation 7 OECD_LI	0.27	0.24	0.26	0.25	0.29	0.31
Equation 8 EUROCOIN	0.26	0.29	0.32	0.39	0.33	0.44

**Table 2b: Real-time exercise: RMSEs of forecasts of euro area real GDP growth***Percentage points - Sample: 2001Q2-2004Q4**Forecasts assessed against first estimates of GDP growth*

	Q+1, M1	Q,M3	Q,M2	Q,M1	Q-1,M3	Q-1,M2
Benchmark AR of GDP	0.24	0.21	0.26	0.28	0.26	0.30
Average forecast	0.17	0.16	0.17	0.22	0.21	0.23
Equation 1 IP, CTRP, SER_VA	0.16	0.17	0.18	0.23	0.21	0.22
Equation 2 IP, CTRP, RS, CARS	0.24	0.20	0.26	0.28	0.24	0.26
Equation 3 ESI	0.23	0.19	0.23	0.25	0.22	0.25
Equation 4 MAN_CONF, SER_CONF	0.16	0.18	0.21	0.19	0.20	0.25
Equation 5 MAN_CONF, RET_CONF, CONS_CONF	0.25	0.26	0.26	0.27	0.27	0.27
Equation 6 FINANCIAL	0.26	0.24	0.25	0.25	0.25	0.28
Equation 7 OECD_LI	0.23	0.19	0.25	0.24	0.24	0.27
Equation 8 EUROCOIN	0.23	0.24	0.29	0.34	0.28	0.39

Notations: IP: industrial production; CTRP: construction production, SER\_VA: services value-added; RS: retail sales; CARS: new passenger car registrations; ESI: European Commission Economic Sentiment Index; MAN\_CONF: manufacturing confidence; SER\_CONF: services confidence; RET\_CONF: retail trade confidence; CONS\_CONF: consumer confidence; FINANCIAL: share prices, interest rate spread and euro effective exchange rate.

Notations: for a given quarter Q, Eurostat publishes a flash estimate of euro area real GDP growth in the second month of the following quarter, "Q+1, M2". Forecasts are calculated in the preceding six months, i.e. from the second month of the quarter preceding Q, "Q-1, M2", to the first month of Q+1, "Q+1, M1". Thus the amount of information on indicators used in the short-term forecasts increases when going from right to left in the tables.

**Table 3a: Differences between RMSEs calculated with real-time and with pseudo real-time exercises***Percentage points - Sample: 2001Q2-2004Q4**Real-time forecasts assessed against current estimates of GDP growth, pseudo real-time against current estimates*

	Q+1, M1	Q,M3	Q,M2	Q,M1	Q-1,M3	Q-1,M2
Benchmark AR of GDP	-0.01	0.00	-0.01	-0.01	0.00	-0.02
Average forecast	0.00	0.00	-0.01	0.00	0.00	-0.01
Equation 1 IP, CTRP, SER_VA	0.03	0.03	-0.01	0.01	0.00	0.00
Equation 2 IP, CTRP, RS, CARS	0.03	0.00	0.01	0.03	0.01	0.00
Equation 3 ESI	-0.01	0.00	-0.01	0.00	0.00	-0.01
Equation 4 MAN_CONF, SER_CONF	0.00	0.00	0.00	0.00	0.00	0.00
Equation 5 MAN_CONF, RET_CONF, CONS_CONF	-0.01	-0.01	-0.01	-0.01	-0.01	-0.01
Equation 6 FINANCIAL	0.00	0.00	0.00	0.00	0.00	-0.01
Equation 7 OECD_LI	-0.02	-0.01	-0.03	-0.01	0.00	-0.04
Equation 8 EUROCOIN	-0.02	0.01	0.03	0.02	-0.01	0.03

**Table 3b: Differences between RMSEs calculated with real-time and with pseudo real-time exercises***Percentage points - Sample: 2001Q2-2004Q4**Real-time forecasts assessed against first estimates of GDP growth, pseudo real-time against current estimates*

	Q+1, M1	Q,M3	Q,M2	Q,M1	Q-1,M3	Q-1,M2
Benchmark AR of GDP	-0.07	-0.07	-0.05	-0.05	-0.06	-0.07
Average forecast	-0.04	-0.04	-0.05	-0.04	-0.06	-0.07
Equation 1 IP, CTRP, SER_VA	-0.01	-0.04	-0.07	-0.06	-0.07	-0.07
Equation 2 IP, CTRP, RS, CARS	0.02	-0.04	-0.04	-0.03	-0.05	-0.04
Equation 3 ESI	-0.06	-0.06	-0.04	-0.04	-0.06	-0.06
Equation 4 MAN_CONF, SER_CONF	-0.03	-0.03	-0.04	-0.05	-0.07	-0.08
Equation 5 MAN_CONF, RET_CONF, CONS_CONF	-0.02	-0.01	-0.02	-0.02	-0.04	-0.05
Equation 6 FINANCIAL	0.00	0.00	0.00	0.00	-0.01	-0.02
Equation 7 OECD_LI	-0.06	-0.05	-0.04	-0.01	-0.05	-0.08
Equation 8 EUROCOIN	-0.05	-0.04	0.00	-0.03	-0.07	-0.02

Notations: for a given quarter Q, Eurostat publishes a flash estimate of euro area real GDP growth in the second month of the following quarter, “Q+1, M2”. Forecasts are calculated in the preceding six months, i.e. from the second month of the quarter preceding Q, “Q-1, M2”, to the first month of Q+1, “Q+1, M1”. Thus the amount of information on indicators used in the short-term forecasts increases when going from right to left in the tables.

**Table 4: Differences between forecasts calculated with vintage data and forecasts calculated in pseudo real-time exercise**  
Forecasts of quarter-on-quarter GDP growth rates (non annualised) – Percentage point differences between forecasts

	Q+1, M1			Q,M3			Q,M2		
	Average	RMS	Max	Average	RMS	Max	Average	RMS	Max
Benchmark AR of GDP	-0.03	0.06	0.12	-0.03	0.07	0.17	-0.03	0.06	0.11
Average forecast	-0.01	0.04	0.08	-0.02	0.05	0.12	-0.02	0.04	0.07
Equation 1 IP, CTRP, SER_VA	-0.02	0.10	0.20	-0.04	0.10	0.22	-0.02	0.06	0.12
Equation 2 IP, CTRP, RS, CARS	0.02	0.17	0.30	0.00	0.10	0.21	-0.03	0.08	0.18
Equation 3 ESI	-0.01	0.03	0.06	-0.02	0.04	0.09	-0.02	0.03	0.06
Equation 4 MAN_CONF, SER_CONF	-0.01	0.01	0.03	-0.01	0.02	0.04	-0.01	0.02	0.02
Equation 5 MAN_CONF, RET_CONF, CONS_CONF	-0.01	0.01	0.03	-0.01	0.02	0.04	-0.01	0.02	0.03
Equation 6 FINANCIAL	-0.01	0.01	0.03	-0.01	0.02	0.04	-0.02	0.02	0.04
Equation 7 OECD_LI	-0.03	0.06	0.11	-0.05	0.09	0.22	-0.05	0.09	0.19
Equation 8 EUROCOIN	-0.03	0.08	0.23	-0.06	0.18	0.56	-0.01	0.17	0.48
	Q,M1			Q-1,M3			Q-1,M2		
	Average	RMS	Max	Average	RMS	Max	Average	RMS	Max
Benchmark AR of GDP	-0.03	0.05	0.09	-0.03	0.06	0.14	-0.03	0.05	0.09
Average forecast	-0.01	0.02	0.05	-0.03	0.04	0.11	-0.02	0.03	0.09
Equation 1 IP, CTRP, SER_VA	0.00	0.05	0.11	-0.01	0.03	0.06	-0.02	0.03	0.06
Equation 2 IP, CTRP, RS, CARS	0.00	0.07	0.15	-0.01	0.05	0.10	-0.03	0.07	0.11
Equation 3 ESI	-0.01	0.02	0.04	-0.02	0.02	0.05	-0.02	0.02	0.04
Equation 4 MAN_CONF, SER_CONF	-0.01	0.01	0.02	-0.01	0.02	0.03	-0.01	0.01	0.02
Equation 5 MAN_CONF, RET_CONF, CONS_CONF	-0.01	0.02	0.03	-0.02	0.02	0.04	-0.02	0.02	0.03
Equation 6 FINANCIAL	-0.01	0.02	0.04	-0.02	0.02	0.04	-0.02	0.02	0.05
Equation 7 OECD_LI	-0.03	0.06	0.11	-0.05	0.09	0.18	-0.04	0.08	0.18
Equation 8 EUROCOIN	-0.03	0.11	0.27	-0.08	0.22	0.67	-0.01	0.20	0.58

Notations: for a given quarter Q, Eurostat publishes a flash estimate of euro area real GDP growth in the second month of the following quarter, “Q+1, M2”. Forecasts are calculated in the preceding six months, i.e. from the second month of the quarter preceding Q, “Q-1, M2”, to the first month of Q+1, “Q+1, M1”. Thus the amount of information on indicators used in the short-term forecasts increases when going from right to left in the tables.

Figure 1 – Timing of releases of data on euro area activity during and for the second quarter of 2005

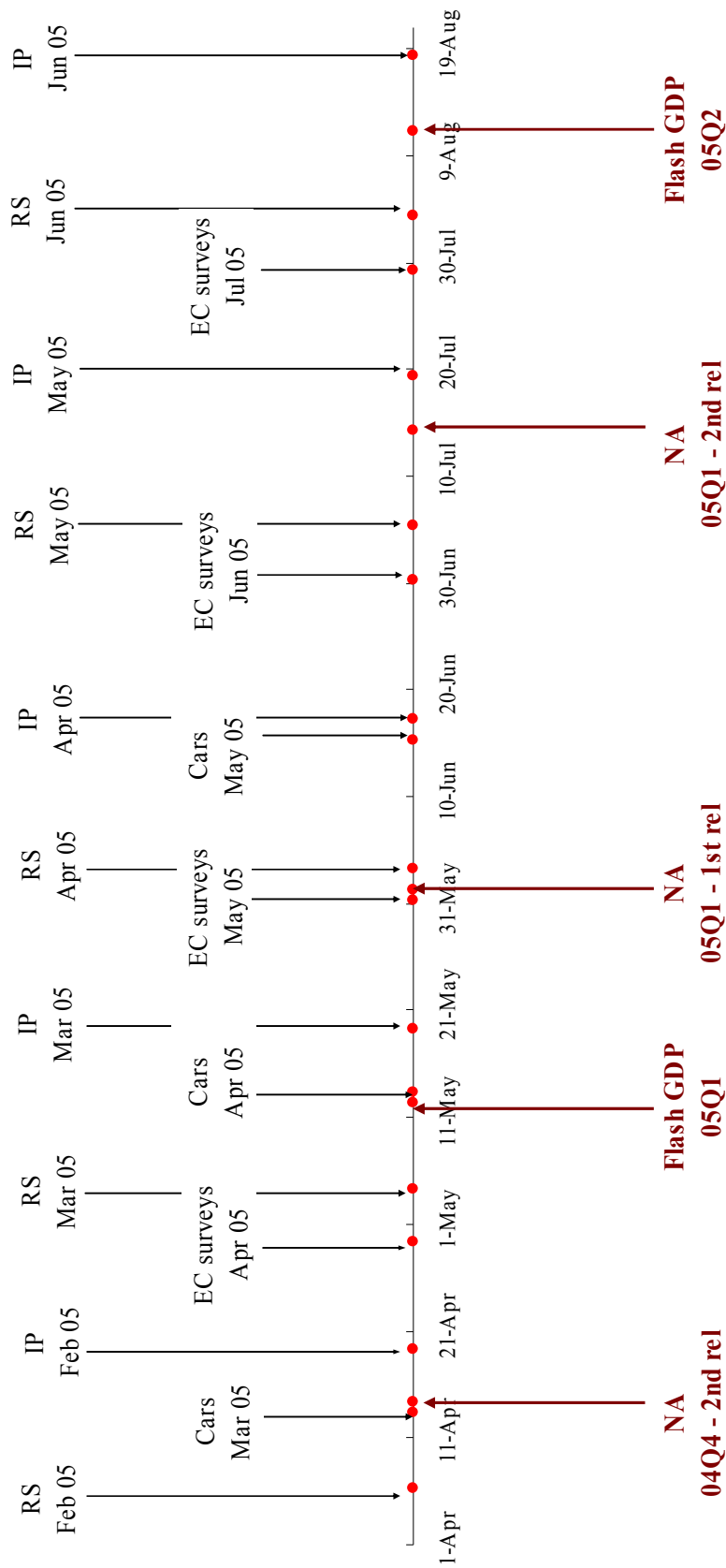

Notations: IP: industrial production; RS: retail sales; Cars: new passenger car registrations; NA: national accounts  
 There is no release of new passenger car registrations in July.

**Figure 2 – Illustration of timing of forecasts**  
*Example of the second quarter of 2005*

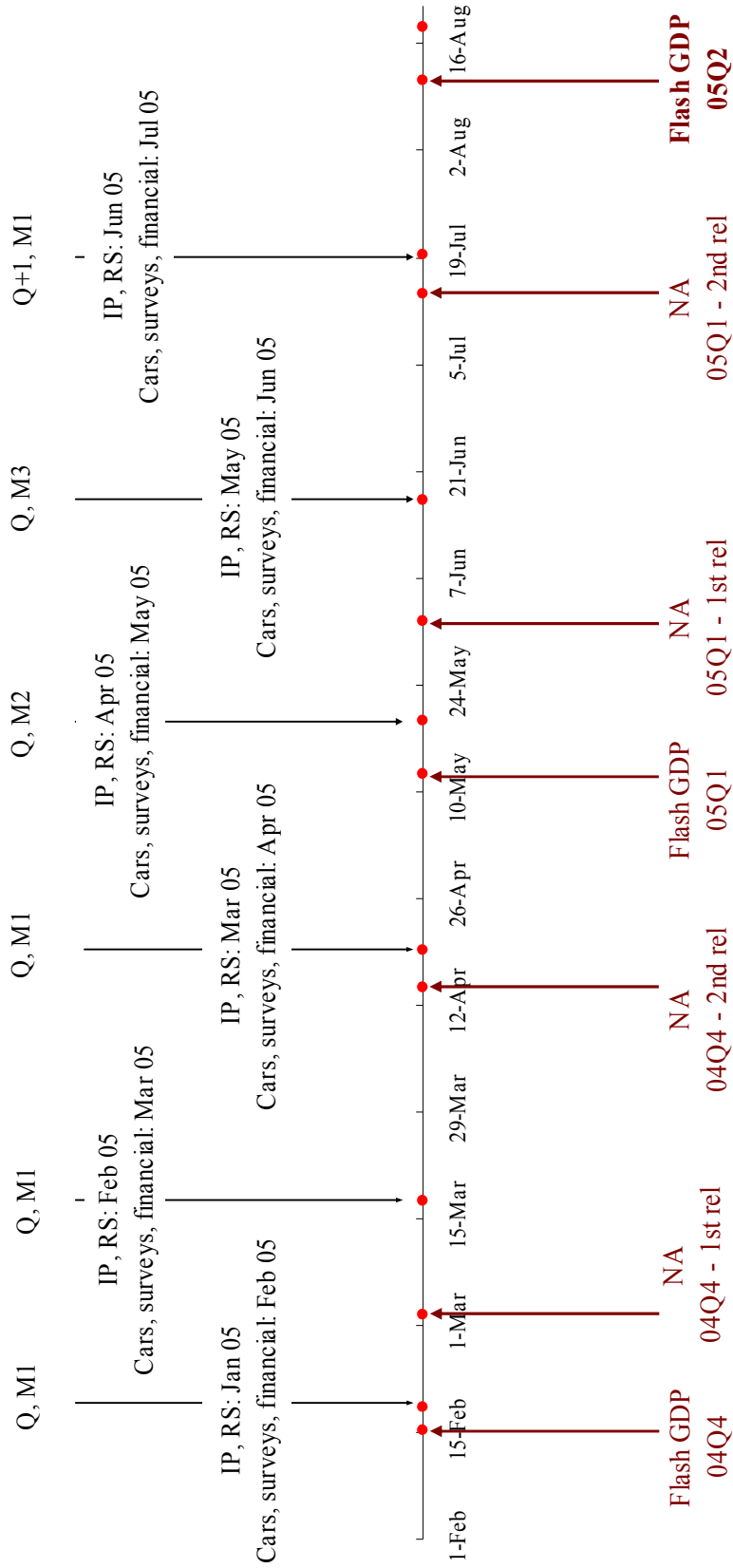

**Figure 3 – Revisions in GDP growth and indicators – Current estimates compared with first estimates**  
*All variables in quarter-on-quarter growth rates (percentages) except EuroCOIN in levels*

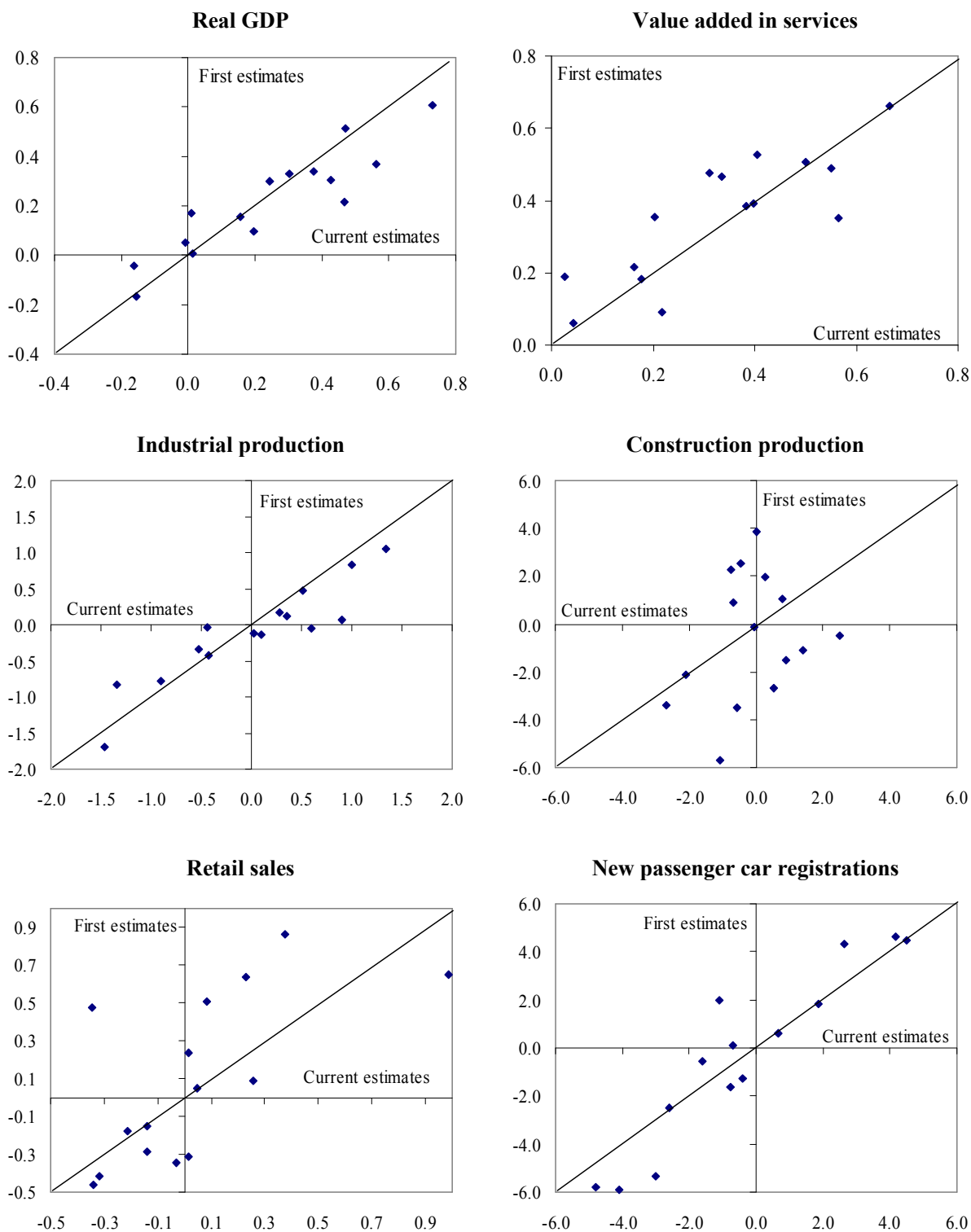

**EuroCOIN**

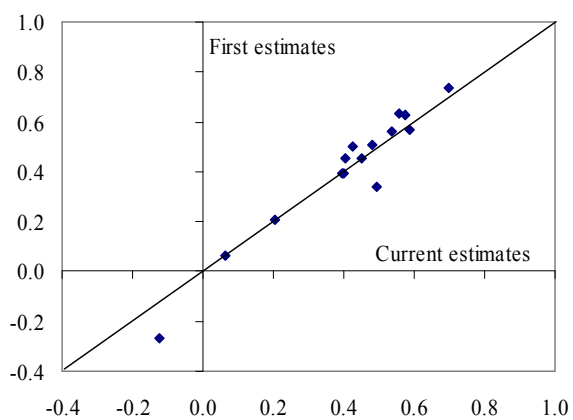

**OECD leading indicator**

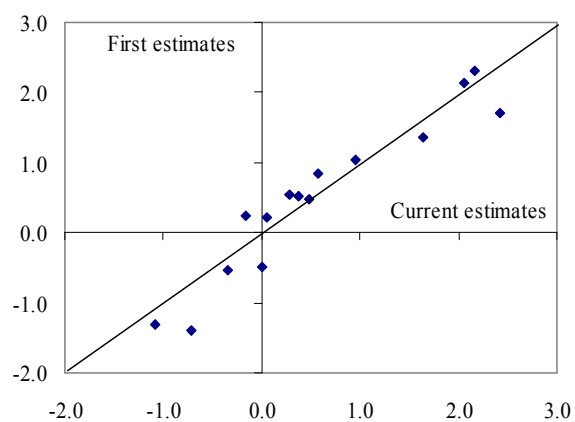

**Figure 4 – Average forecast across equations based on current estimates and real-time data**  
*Quarter-on-quarter growth rates*

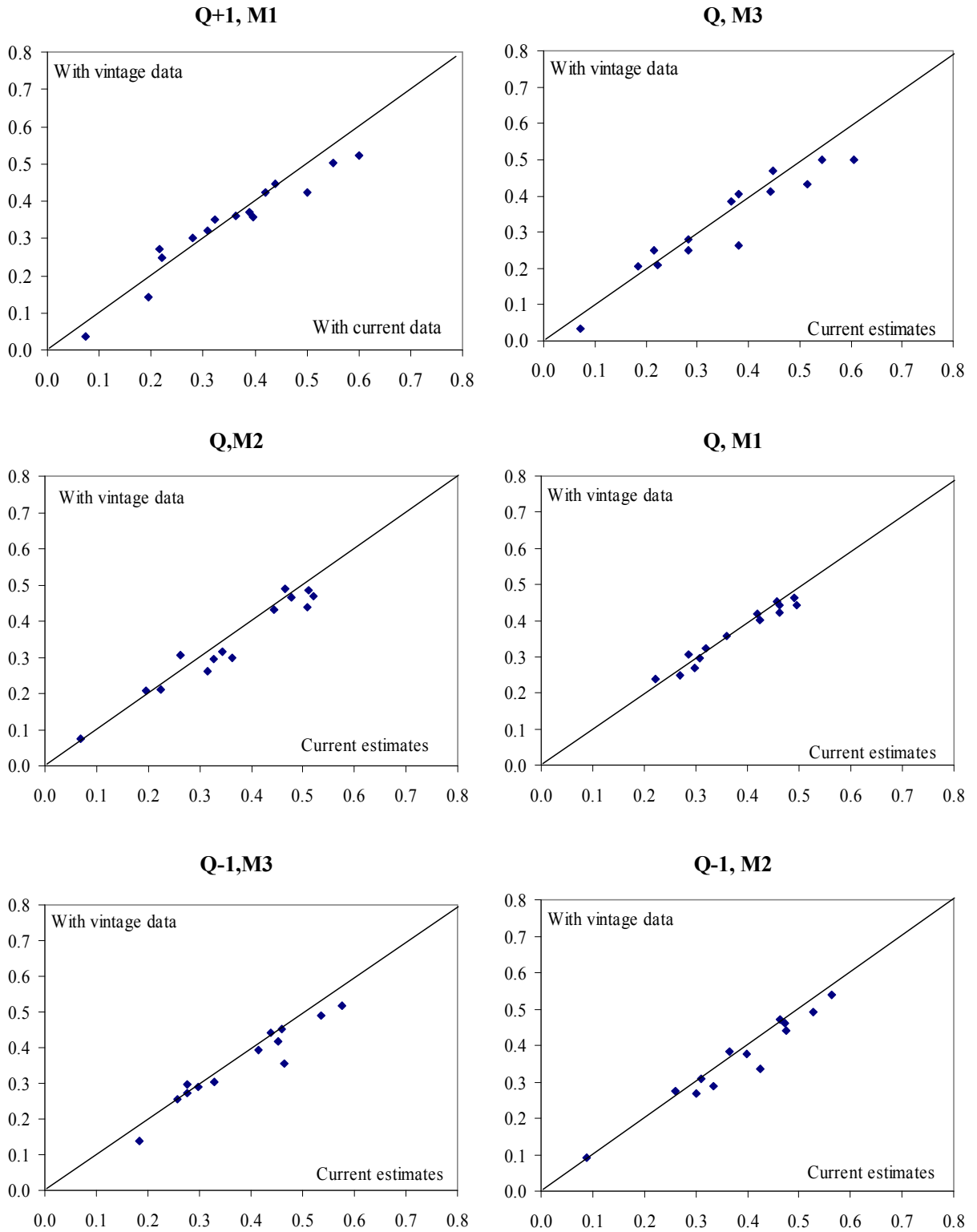
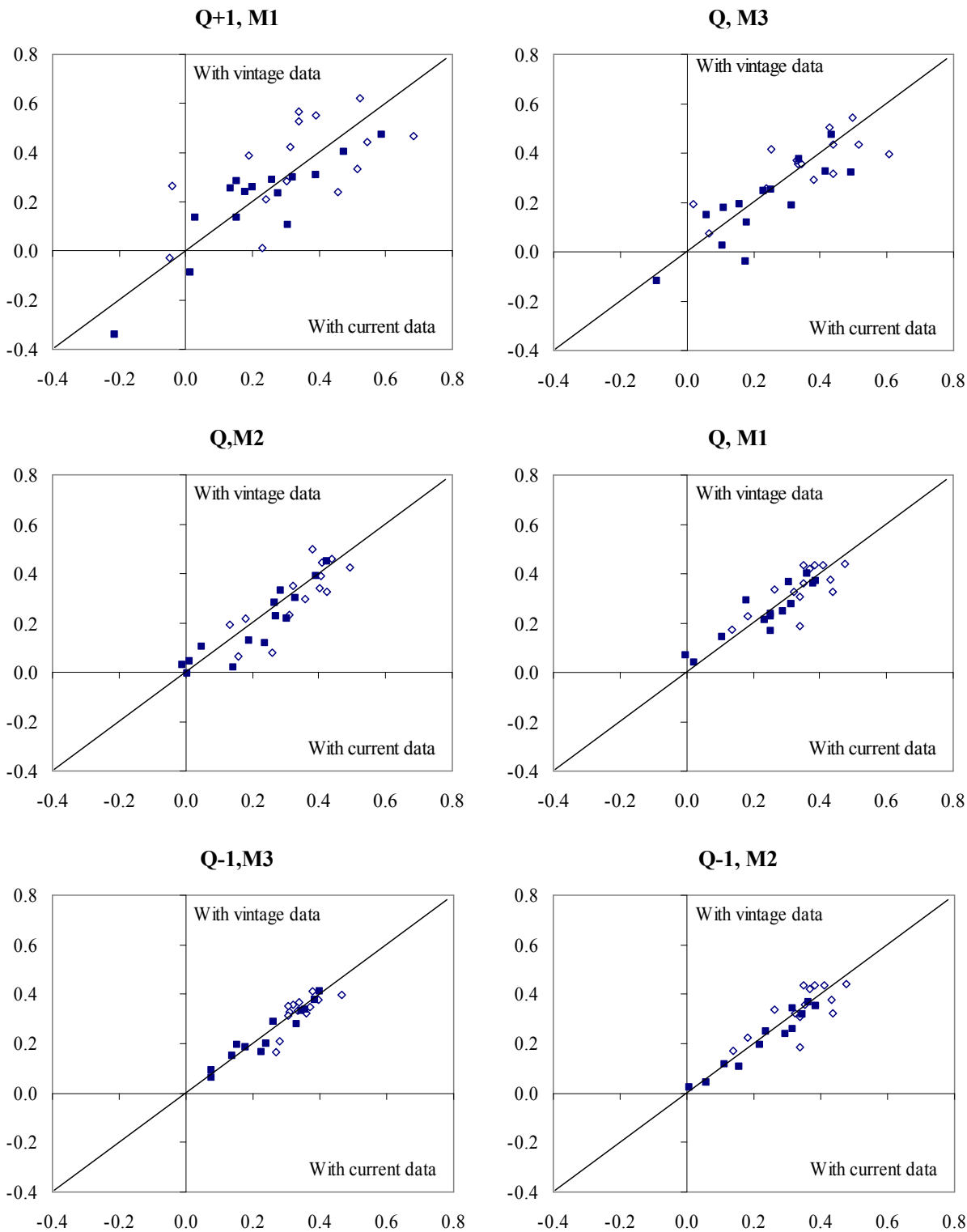



**Figure 5 – Forecasts from equations (1) and (2) based on current estimates and real-time data**

*Quarter-on-quarter growth rates*

■ Forecasts from equation (1) - ◇ Forecasts from equation (2)



**Figure 6 – Decomposition of forecast errors**  
*Percentage points*

- Overall
- Equation
- ▲ Revisions in monthly var
- × Revisions in GDP
- Extrapolation

**Average forecast**

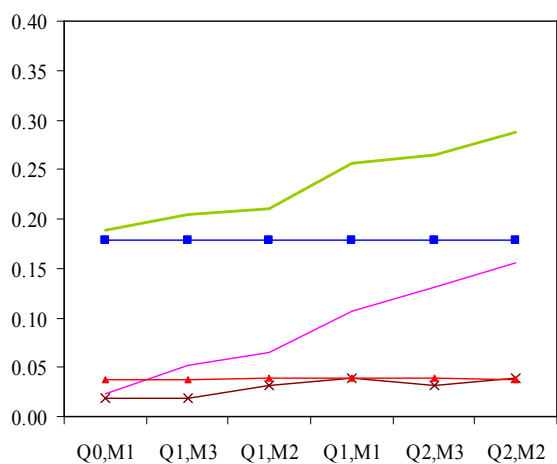

**Equation 1: IP, CTRP, SER\_VA**

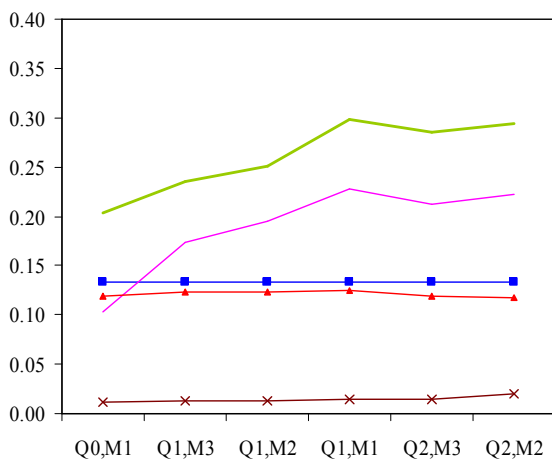

**Equation 2: IP, CTRP, RS, CARS**

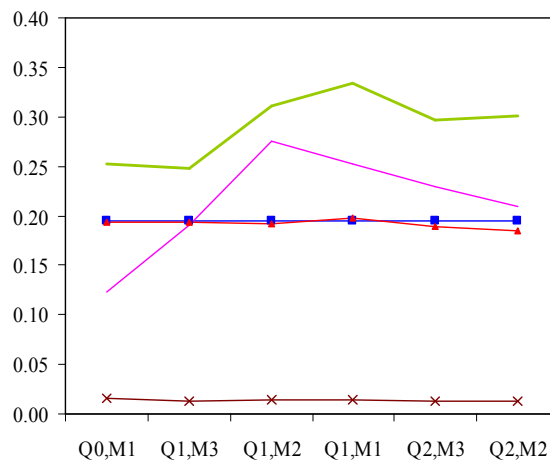

**Equation 3: ESI**

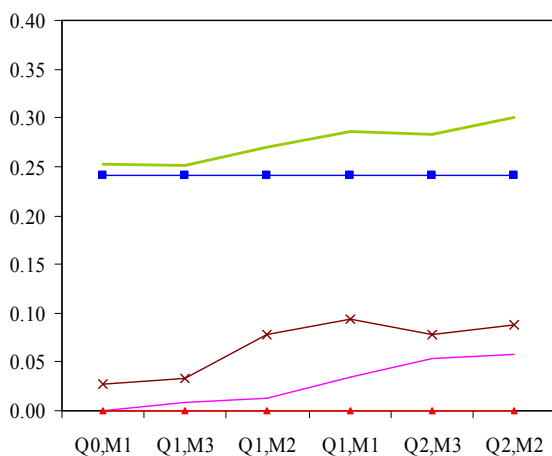

**Equation 4: MAN\_CONF, SER\_CONF**

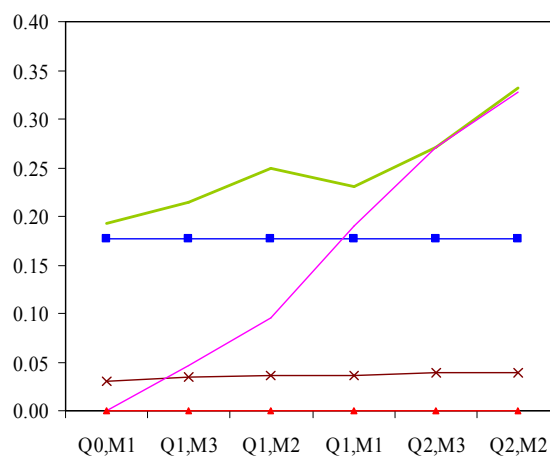

— Overall  
—■— Equation  
—▲— Revisions in monthly var

—×— Revisions in GDP  
— Extrapolation

**Equation 5: MAN\_CONF, RET\_CONF, CONS\_CONF**

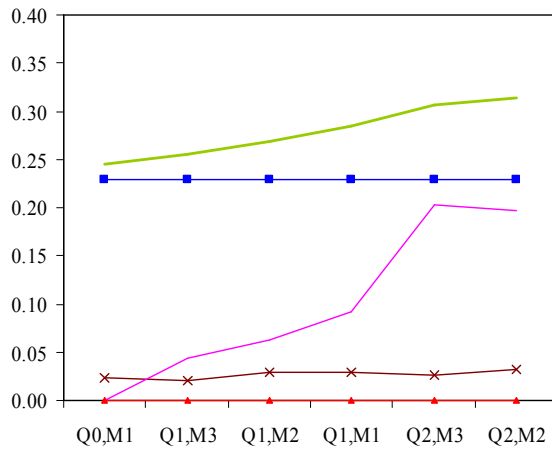

**Equation 6: FINANCIAL**

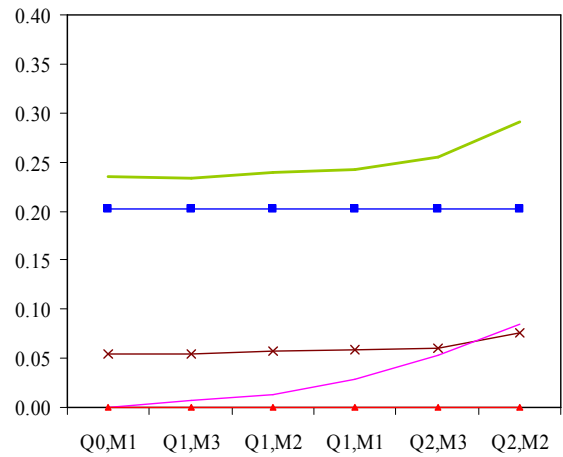

**Equation 7: OECD\_LI**

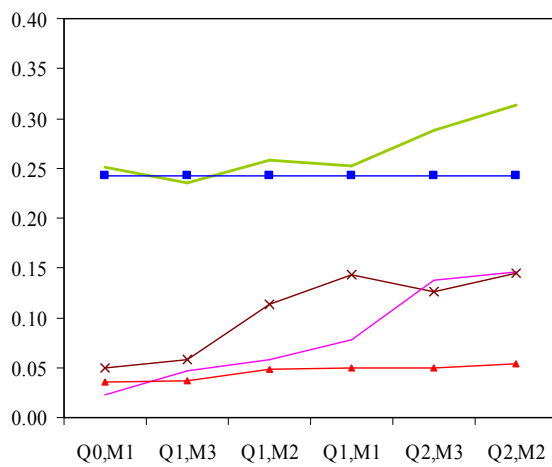

**Equation 8: EUROCOIN**

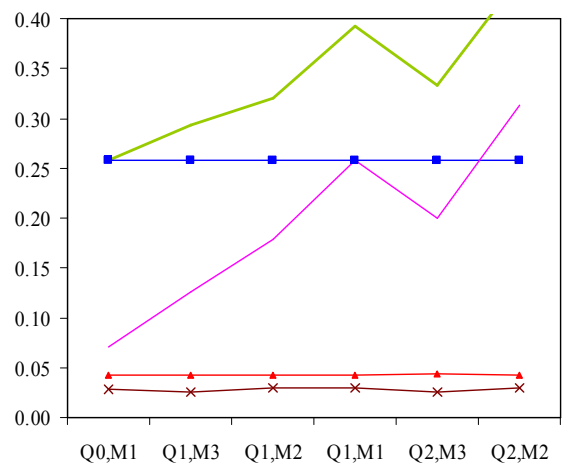

### Appendix 1: data sources and descriptions

The data vintages used in this paper correspond to data available on the day of the release of euro area industrial production data, which occur around the middle of the month.

Mnemonic	Series	Source	Backdating when relevant
GDP	Real GDP	Eurostat	Backdated with the Area Wide Model GDP series pre-1991
VA_SER	Value-added in services sector	Eurostat	Backdated by splicing growth rates of the aggregation of available country data pre-1991
IP	Industrial production excluding construction	Eurostat	
CTRP	Construction production	Eurostat	By the ECB statistics department Aggregation of available country data pre-1988
RS	Retail sales volumes	Eurostat	By the ECB statistics department Aggregation of available country data pre-1995
CARS	New passenger car registrations	ACEA	Backdated pre-1990 with OECD data
ESI	Economic Sentiment Index	European Commission DG-ECFIN	
MAN_CONF	Business confidence in manufacturing sector	European Commission DG-ECFIN	
SER_CONF	Business confidence in services sector	European Commission DG-ECFIN	Backdated by inverting regression of value-added in services on services confidence pre-1995
RET_CONF	Business confidence in retail trade sector	European Commission DG-ECFIN	
CONS_CONF	Consumer confidence	European Commission DG-ECFIN	
SPI	Share price index deflated by HICP inflation	Datastream, Eurostat	
SPREAD	Difference between 10-year government bond yields and 3-month interest rates	ECB	
EER	Euro effective exchange rate against group of 30 main trading partners	ECB	
ECOIN	EuroCOIN	CEPR	
OECD_LI	OECD leading indicator for the euro area	OECD	

All data are seasonally adjusted by the publishing institution except for new passenger car registrations (seasonal adjustment by the ECB statistics department) and financial variables which are not seasonally adjusted.

## European Central Bank Working Paper Series

For a complete list of Working Papers published by the ECB, please visit the ECB's website (<http://www.ecb.int>)

- 585 "Are specific skills an obstacle to labor market adjustment? Theory and an application to the EU enlargement" by A. Lamo, J. Messina and E. Wasmer, February 2006.
- 586 "A method to generate structural impulse-responses for measuring the effects of shocks in structural macro models" by A. Beyer and R. E. A. Farmer, February 2006.
- 587 "Determinants of business cycle synchronisation across euro area countries" by U. Böwer and C. Guillemineau, February 2006.
- 588 "Rational inattention, inflation developments and perceptions after the euro cash changeover" by M. Ehrmann, February 2006.
- 589 "Forecasting economic aggregates by disaggregates" by D. F. Hendry and K. Hubrich, February 2006.
- 590 "The pecking order of cross-border investment" by C. Daude and M. Fratzscher, February 2006.
- 591 "Cointegration in panel data with breaks and cross-section dependence" by A. Banerjee and J. L. Carrion-i-Silvestre, February 2006.
- 592 "Non-linear dynamics in the euro area demand for MI" by A. Calza and A. Zaghini, February 2006.
- 593 "Robustifying learnability" by R. J. Tetlow and P. von zur Muehlen, February 2006.
- 594 "The euro's trade effects" by R. Baldwin, comments by J. A. Frankel and J. Melitz, March 2006.
- 595 "Trends and cycles in the euro area: how much heterogeneity and should we worry about it?" by D. Giannone and L. Reichlin, comments by B. E. Sørensen and M. McCarthy, March 2006.
- 596 "The effects of EMU on structural reforms in labour and product markets" by R. Duval and J. Elmeskov, comments by S. Nickell and J. F. Jimeno, March 2006.
- 597 "Price setting and inflation persistence: did EMU matter?" by I. Angeloni, L. Aucremanne, M. Ciccarelli, comments by W. T. Dickens and T. Yates, March 2006.
- 598 "The impact of the euro on financial markets" by L. Cappiello, P. Hördahl, A. Kadareja and S. Manganeli, comments by X. Vives and B. Gerard, March 2006.
- 599 "What effects is EMU having on the euro area and its Member Countries? An overview" by F. P. Mongelli and J. L. Vega, March 2006.
- 600 "A speed limit monetary policy rule for the euro area" by L. Stracca, April 2006.
- 601 "Excess burden and the cost of inefficiency in public services provision" by A. Afonso and V. Gaspar, April 2006.

- 602 “Job flow dynamics and firing restrictions: evidence from Europe” by J. Messina and G. Vallanti, April 2006.
- 603 “Estimating multi-country VAR models” by F. Canova and M. Ciccarelli, April 2006.
- 604 “A dynamic model of settlement” by T. Koepl, C. Monnet and T. Temzelides, April 2006.
- 605 “(Un)Predictability and macroeconomic stability” by A. D’Agostino, D. Giannone and P. Surico, April 2006.
- 606 “Measuring the importance of the uniform nonsynchronization hypothesis” by D. A. Dias, C. Robalo Marques and J. M. C. Santos Silva, April 2006.
- 607 “Price setting behaviour in the Netherlands: results of a survey” by M. Hoeberichts and A. Stokman, April 2006.
- 608 “How does information affect the comovement between interest rates and exchange rates?” by M. Sánchez, April 2006.
- 609 “The elusive welfare economics of price stability as a monetary policy objective: why New Keynesian central bankers should validate core inflation” by W. H. Buiter, April 2006.
- 610 “Real-time model uncertainty in the United States: the Fed from 1996-2003” by R. J. Tetlow and B. Ironside, April 2006.
- 611 “Monetary policy, determinacy, and learnability in the open economy” by J. Bullard and E. Schaling, April 2006.
- 612 “Optimal fiscal and monetary policy in a medium-scale macroeconomic model” by S. Schmitt-Grohé and M. Uribe, April 2006.
- 613 “Welfare-based monetary policy rules in an estimated DSGE model of the US economy” by M. Juillard, P. Karam, D. Laxton and P. Pesenti, April 2006.
- 614 “Expenditure switching vs. real exchange rate stabilization: competing objectives for exchange rate policy” by M. B. Devereux and C. Engel, April 2006.
- 615 “Quantitative goals for monetary policy” by A. Fatás, I. Mihov and A. K. Rose, April 2006.
- 616 “Global financial transmission of monetary policy shocks” by M. Ehrmann and M. Fratzscher, April 2006.
- 617 “New survey evidence on the pricing behaviour of Luxembourg firms” by P. Lünemann and T. Y. Mathä, May 2006.
- 618 “The patterns and determinants of price setting in the Belgian industry” by D. Cornille and M. Dossche, May 2006.
- 619 “Cyclical inflation divergence and different labor market institutions in the EMU” by A. Campolmi and E. Faia, May 2006.
- 620 “Does fiscal policy matter for the trade account? A panel cointegration study” by K. Funke and C. Nickel, May 2006.

- 621 “Assessing predetermined expectations in the standard sticky-price model: a Bayesian approach” by P. Welz, May 2006.
- 622 “Short-term forecasts of euro area real GDP growth: an assessment of real-time performance based on vintage data” by M. Diron, May 2006.

ISSN 1561081-0



9 771561 081005